

# Controller unit for solar thermal systems

## **primos 600 SR**



## Installation and operating instructions

English version of original German installation and operating instructions

Version: 1.4

June 2016

# Terminology

In order to facilitate the use of the assembly and operating instructions, the following terminology will be used:

- These installation and operating instructions will hereinafter be designated as "Instructions".
- The primos 600 SR controller will hereinafter be designated as "Controller".
- The thermal solar power plant will hereinafter be designated as "Solar power plant".
- Freely definable Prozeda function modules, complete with selectable inputs and outputs, will hereinafter be designated as "Multi-function controllers" (MFC).
- Prozeda GmbH will hereinafter be designated as the "Manufacturer".

# Declaration of conformity

The product complies with the regulatory requirements and standards on CE conformity and therefore carries the CE mark.

This manual is designed to help you use the controller properly, safely and economically.

## **Target group**

This manual is addressed to all persons who carry out any of the following tasks:

- Installing the controller
- Connecting the controller
- Putting the controller into operation
- Setting the controller
- Maintaining the solar power system
- Eliminating faults on the controller and the solar power system
- Disposing of the controller

These persons must have the following knowledge and skills:

- Knowledge about establishing electrical connections
- Knowledge about the hydraulic operation of solar power systems
- Knowledge of the applicable regulations at the point of use and the ability to apply them

These persons must have read and understood the contents of this manual.

## **Availability**

This manual is part of the controller. Always keep it in an easily accessible location. Include this manual with the controller should the controller change hands.

If this manual gets lost or becomes unusable, you can contact the manufacturer for a new copy.

## Style conventions used in the text

Specific style conventions are assigned to different elements in the manual. This makes it easy to recognise the type of text concerned:

Standard text,

"Menu", "Menu item", "Button designations",

- lists and
- actions.

 Notes accompanied by this symbol contain information about how to operate the controller economically.

## Style conventions for hazard warnings

This manual makes reference to the following categories of hazard warnings:



### **DANGER**

Information or instructions accompanied by the word DANGER provide a warning about a hazardous situation that will lead to fatal or serious injuries.

---



### **WARNING**

Information or instructions accompanied by the word WARNING provide a warning about a hazardous situation that may possibly lead to fatal or serious injuries.

---



### **CAUTION**

Information or instructions accompanied by the word CAUTION provide a warning about a situation that can lead to minor or moderate injuries.

---

## Style conventions for warnings of damage to property or the environment

---

### ***ATTENTION***

Information and instructions of this kind provide a warning about a situation that can lead to damage to property or the environment.

---

---

# Table of contents

<b>1</b>	<b>Safety.....</b>	<b>7</b>
1.1	Proper use .....	7
1.2	Basic safety information .....	7
<b>2</b>	<b>Description of the controller .....</b>	<b>9</b>
2.1	Overview.....	9
<b>3</b>	<b>Installing the controller .....</b>	<b>10</b>
3.1	Removing the terminal cover .....	11
3.2	Fastening the controller .....	12
<b>4</b>	<b>Connecting the controller .....</b>	<b>13</b>
4.1	Connecting cables to the controller .....	13
4.2	Connecting the controller to the power supply.....	15
4.3	Connecting temperature sensors .....	15
<b>5</b>	<b>Assignment of the terminals to the system components .....</b>	<b>16</b>
<b>6</b>	<b>Operating the controller.....</b>	<b>23</b>
6.1	Description of the display elements .....	23
6.2	Using the operating buttons.....	25
<b>7</b>	<b>Displaying and changing the values in the menus.....</b>	<b>26</b>
7.1	Displaying values in the "Info" menu.....	26
7.2	Displaying and changing values in the "Program" menu .....	28
7.3	Controlling switching outputs in the "Manual mode" menu.....	31
7.4	Displaying and changing values in the "Basic settings" menu .....	32
<b>8</b>	<b>Setting the control functions .....</b>	<b>37</b>
8.1	Setting the charging principle .....	37
8.2	Setting the "Storage tank priority" function.....	38
8.3	Setting the "Parallel charging" function .....	38
8.4	Setting the pump control system .....	39
8.5	Setting the "Tube collector" functions .....	41
<b>9</b>	<b>Setting multi-function controllers (MFC).....</b>	<b>42</b>
9.1	Setting the "Cooling" function.....	42
9.2	Setting the "Heating" function .....	43
9.3	Setting the "Return flow boost" function .....	43
9.4	Setting the "Temperature difference controller" function.....	44
<b>10</b>	<b>Setting protective functions .....</b>	<b>45</b>
10.1	Setting the "Collector protection" function.....	45
10.2	"Storage tank protection" function .....	45
10.3	"System protection" function.....	45
10.4	Setting the "Recooling" function .....	46

---

10.5	Setting the "Drain-back" function.....	46
10.6	Setting the "Anti-freeze protection" function.....	47
<b>11</b>	<b>Measuring energy output.....</b>	<b>48</b>
11.1	Flow sensor (DFG).....	48
11.2	VFS (Vortex Flow Sensor).....	48
11.3	Flow indicator.....	48
11.4	Setting the energy output measurements.....	49
<b>12</b>	<b>Restore factory settings.....</b>	<b>49</b>
<b>13</b>	<b>Networking the controller with other devices.....</b>	<b>49</b>
<b>14</b>	<b>Faults.....</b>	<b>50</b>
14.1	Faults with fault message.....	50
14.2	Faults without fault message.....	52
<b>15</b>	<b>Technical data.....</b>	<b>54</b>
<b>16</b>	<b>Resistance table.....</b>	<b>55</b>
<b>17</b>	<b>Accessories.....</b>	<b>55</b>
<b>18</b>	<b>Disposing of the controller.....</b>	<b>56</b>

# 1 Safety

This chapter contains information on:

- the proper use of the controller and
- the safe use of the controller.

Read this chapter through carefully before you install, connect or operate the controller.

## 1.1 Proper use

The controller is used for monitoring and controlling a solar thermal system.

Appropriate use of the controller includes the following requirements:

- Use the controller exclusively in dry rooms in residential, commercial and/or industrial environments.
- Use only sensor connection boxes supplied by the manufacturer.
- Use the RS485 interface (ProBusX) only for networking further devices from the manufacturer Prozeda.

The definition of proper use also encompasses observing and complying with all of the information contained in this manual - in particular compliance with all safety information and instructions.

Any other use, or any use exceeding the specifications, will be deemed to be improper use and may lead to personal injury or damage to property and shall render the warranty void.

Use of the controller in the following situations in particular is considered to be improper use:

- If you modify the controller independently and without prior authorisation
- If you operate the controller in a humid or wet environment

The manufacturer shall not be liable for damages arising from inappropriate use.

## 1.2 Basic safety information

This section contains basic safety information relating to working with the controller. You will find additional safety information relating to specific actions and workflows at the beginning of the section concerned.

### Preventing risks of explosion

- Never use the unit in areas where there is a risk of explosion.

## **Preventing risks of fatal injury from electric shocks**

- Make sure that all regulations applicable at the point of use are complied with.
- Always make sure that the controller is disconnected from the power supply before carrying out any work on it.
- Make sure that the connections of the protective extra-low voltage areas do not get mixed up with the power supply connections.
- On completion of installation work, refit the terminal cover and tighten the locking screw using a screwdriver.
- Make sure that the electrical connection of the controller can be disconnected from the mains externally if required.
- Make sure that all cables are secured by strain relief devices.
- Use the device only if it is in a fault-free condition.

## **Preventing risks of fire**

- Install the controller on a non-flammable subsurface.

## **Preventing risks of injury from burns**

- Carry out installation work on the solar power system only when it has cooled down.
- The process water can reach very high temperatures. Exercise particular care when configuring settings on the controller.
- Take water samples after completion of the settings and check them using a suitable thermometer.

## **Preventing damage to property**

- A damaged controller may cause malfunctions in the system as well as damage to its components. Use the controller only if it is in a fault-free condition.
- Install the controller with due observance of its protection class. Information about this can be found in the chapter *Technical Data* from page 57 onwards.
- Make sure that no moisture gets into the controller.
- If any moisture gets into the controller, disconnect the controller from the power supply.
- Make sure that the maximum permissible ambient temperature is not exceeded. Information about this can be found in the chapter *Technical Data* from page 57 onwards.
- Make sure that all components to be connected to the switching outputs are suitable for an operating voltage of 230 V/50 Hz.
- When in "manual mode", the system must only ever be operated for a short time and only for test purposes.
- Install sensor lines separately from 230 V lines.



- Use only sensor connection boxes supplied by the manufacturer.

## 2 Description of the controller

The controller is used for monitoring and controlling a solar thermal system. The controller allows the system to be configured in accordance with the local situation at the place of use and with the requirements of the user. In addition, the controller can be used to carry out system protection functions.

### 2.1 Overview

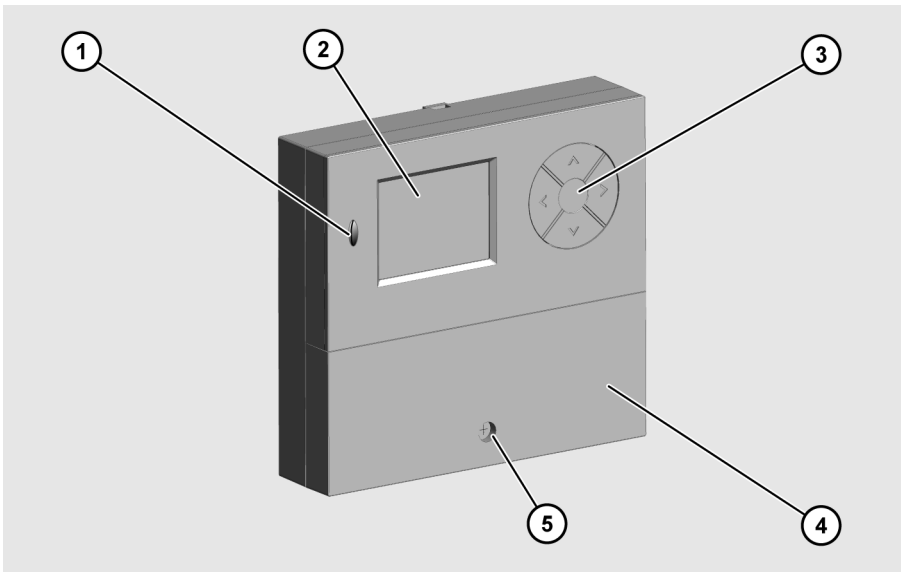

- ① microSD card interface
- ② Display
- ③ Operating buttons
- ④ Terminal cover
- ⑤ Locking screw

The display (2) shows the menus for monitoring and controlling the solar power system. The operating buttons (3) allow you to display and change the parameters.

For data exchange purposes the controller is equipped with a microSD card interface (1).

## 3 Installing the controller

---



### **DANGER**

Risk of fatal injuries due to explosions or fire.

- Never use the controller in areas where there is a risk of explosion.
  - Install the controller on a non-flammable subsurface.
- 
- 



### **DANGER**

Risk of fatal electric shock when working on the opened controller.

- Make sure that the controller is disconnected from the mains voltage before removing the terminal cover.
  - Make sure that the power supply has been secured to prevent it from being switched on again.
  - Check that the controller is free from voltage.
  - Screw the terminal cover securely back in place when work has been completed.
- 
- 

### **ATTENTION**

Risk of damage and malfunctions due to improper storage before connection.

- Store the controller at room temperature for at least four hours before connecting it.
- 

Select an installation location which meets the following requirements:

- The installation location must be at eye level.
- The installation location must be close to the storage tank and the solar circuit pump.
- It must have access to the power supply.
- There must be sufficient space in front of the controller to allow it to be operated.
- If you wish to lead cables and lines through the back of the controller, there must be sufficient space for the cable gland.

### 3.1 Removing the terminal cover

- Undo the locking screw (1).
- To remove the terminal cover (2), pull it off as shown here.

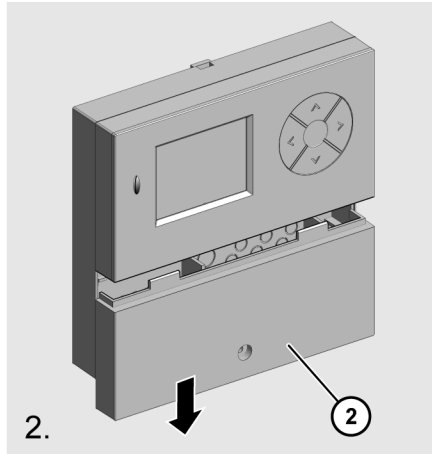
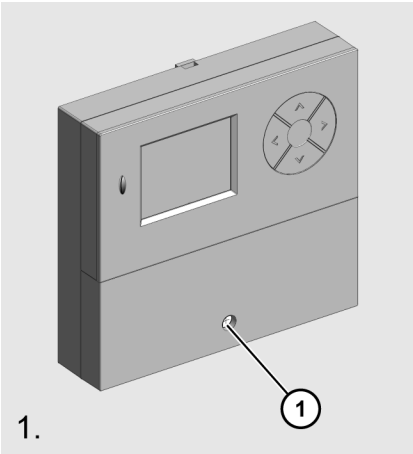

## 3.2 Fastening the controller

- i** If you wish to lead cables and lines through the back of the controller, you need to do this before you fasten it.

### **ATTENTION**

Risk of damage to the controller housing due to screws tightened too firmly.

- Tighten the screws only as firmly as necessary.

- Use only suitable screws and dowels for fastening the controller.
- Hang the controller on the top screw by the keyhole (1).
- Fasten the controller with the screws from the inside through the bottom screw holes (2).

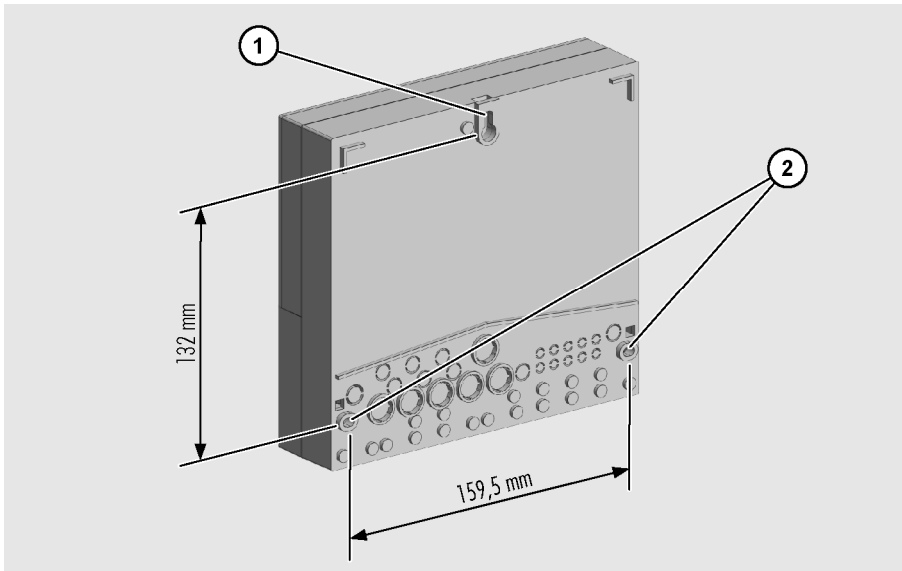

## 4 Connecting the controller

---



### **DANGER**

Risk of fatal electric shock when working on the opened controller.

- Make sure that the controller is disconnected from the mains voltage before removing the terminal cover.
  - Make sure that the power supply has been secured to prevent it from being switched on again.
  - Check that the controller is free from voltage.
  - Screw the terminal cover securely back in place when work has been completed.
- 
- 



### **DANGER**

Risk of fatal electric shock due to ripped out cables.

- Make sure that all cables are adequately secured in position by screw clamps.
  - Make sure that there is no pull on the cables.
- 
- 

### ***ATTENTION***

Risk of damage to the controller and the solar power system due to the connection of unsuitable system components.

- Make sure that the operating voltage of the system components matches that of the controller. Information about this can be found in the chapter *Technical Data* from page **Fehler! Textmarke nicht definiert.** onwards.
- 
- 

### ***ATTENTION***

Risk of damage and malfunctions due to improper storage before connection.

- Store the controller at room temperature for at least four hours before connecting it.
- 

### 4.1 Connecting cables to the controller

- Make sure that the cables and the controller are disconnected from the voltage.
- Remove the terminal cover.

Information about this can be found in the section *Removing the terminal cover* from page **Fehler! Textmarke nicht definiert. Fehler! Textmarke nicht definiert.** onwards

---

The following illustration shows the elements of the controller that are important for connection:

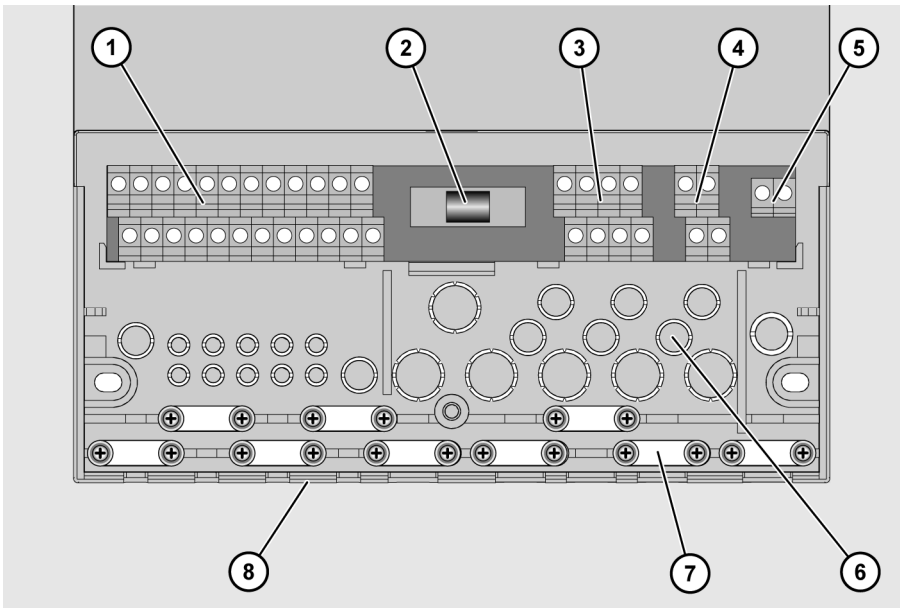

Pos.	Description
1	Terminals for extra-low voltage area
2	Fuse
3	Terminals for 230 V area
4	Terminals for protective conductor
5	Terminals for relay contact
6	Cut-out apertures for cable feedthrough at the back
7	Screw clamps for securing the cables
8	Cut-out apertures for cable feedthrough on the underside

➤ Connect the cables to the corresponding terminals.

Information about connecting the system components to the corresponding terminals can be found in the section *Assignment of the terminals to the system components* from page 15 onwards.

➤ Screw the terminal cover securely back in place.

## 4.2 Connecting the controller to the power supply

When making the mains connection, you must ensure that the mains supply can be disconnected at any time. If you make a permanent mains connection, proceed as follows:

- Install a switch outside the controller.

If you make the mains connection complete with cable and earthing pin plug, proceed as follows:

- Make sure that the earthing pin plug is easily accessible.

## 4.3 Connecting temperature sensors

---

### ***ATTENTION***

Risk of damage and malfunctions on the controller due to improper connection of the temperature sensors.

- Use only sensor connection boxes supplied by the manufacturer.
  - Use only shielded cables for line extensions.
  - Connect the shield of the extension cable to a PE terminal.
  - Install sensor lines separately from 230 V lines.
- 

Use cables with the following cross-sections for line extensions:





- Up to 15 m:  $2 \times 0.5 \text{ mm}^2$
- 15 to 50 m:  $2 \times 0.75 \text{ mm}^2$



When connecting the temperature sensors, you do not need to observe polarity for the two wires.

## 5 Assignment of the terminals to the system components

The connections in the following table are options that may be used in all hydraulic layouts:

Terminal	Use
S4 / S4	Temperature sensor for the collector return for the "Energy output measurement" function
S6 / S6	Temperature display
S7 / S7	Radiation sensor input (white core of the radiation sensor at S7, red core at M)
	Flow sensor for the "Energy output measurement" function
	VFS (Vortex Flow Sensor) for the "Flow Monitoring" function S8=Flow S9= Temperature Further details can be found in the VFS manufacturer's documentation
	RS-485- interface (ProBusX) Make sure that the polarity of the bus connection is not mixed up (A-A, B-B). Use paired twisted-conductor cables for connection
	Power control for high-efficiency pump (HE pump) 1. HE1=Signal M1=GND 230 V power supply for the pump via switching output R1.
	Power control for high-efficiency pump (HE pump) 2. HE2=Signal M2=GND 230 V power supply for the pump via switching output R2.

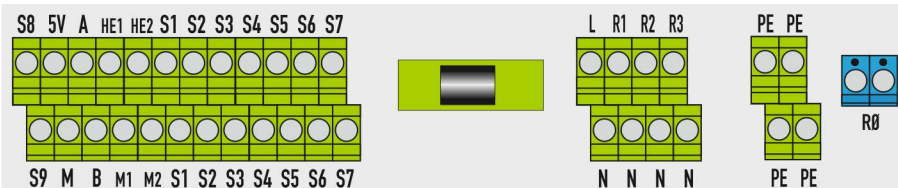



### Terminal assignment for hydraulic layouts 110.00, 111.00, 112.00

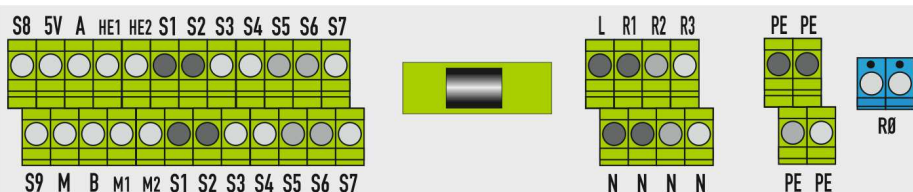
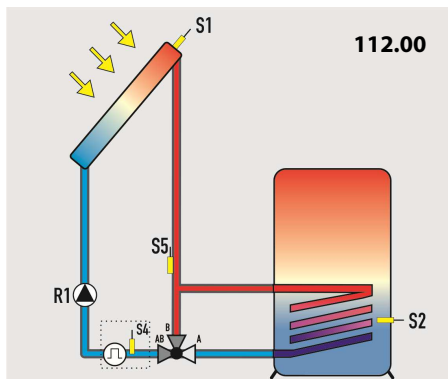
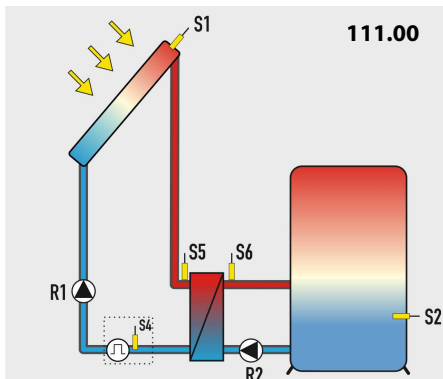
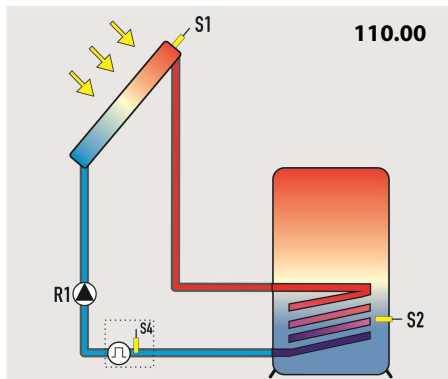

Terminal	Use
R1 / N / PE	Solar circuit pump, 230 V connection. Power control for high-efficiency pump on HE1/M1
(R2 / N / PE)	111.00: Secondary pump. Power control for high-efficiency pump on HE2/M2. 112.00: Three-way valve for bypass function
S1 / S1	Temperature sensor for collector
S2 / S2	Temperature sensor for storage tank
(S5 / S5)	111.00: Temperature sensor for collector feed
(S6 / S6)	111.00: Temperature sensor for storage tank feed
(S4 / S4)	Temperature sensor of the collector return line for the "Energy yield measurement" function

## Terminal assignment for hydraulic layouts 210.01, 211.01, 212.01

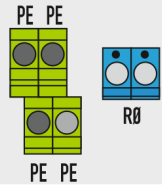
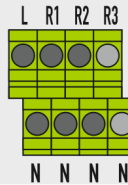
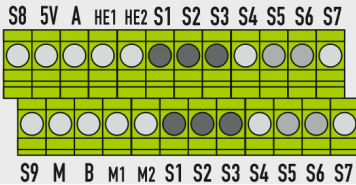
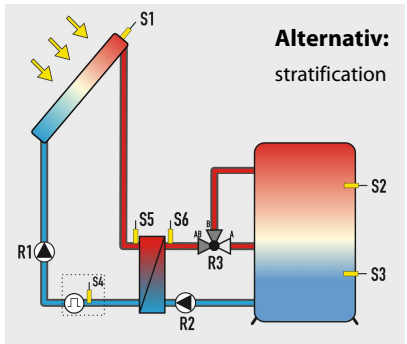
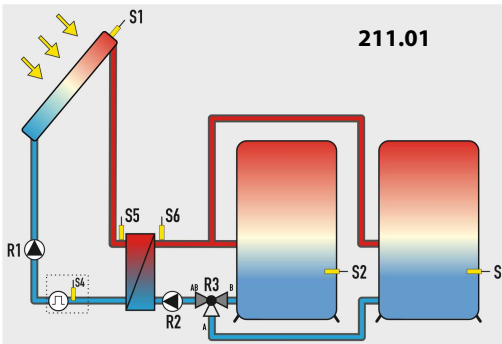
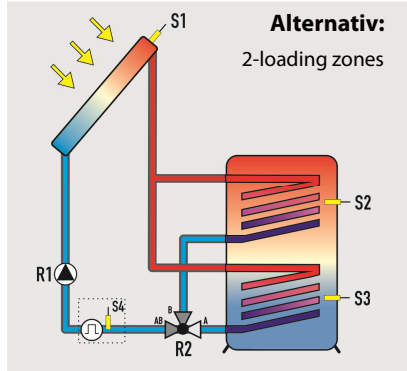
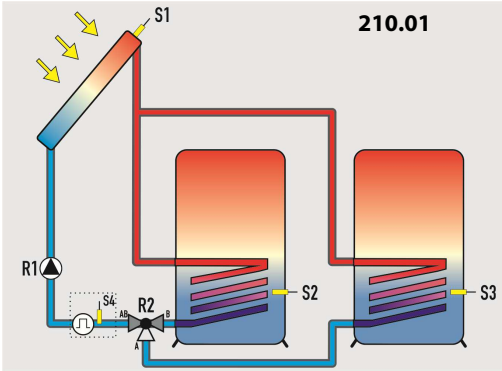

Terminal	Use
R1 / N / PE	Solar circuit pump, 230 V connection. Power control for high-efficiency pump on HE1/M1
R2 / N / PE	210.01: Three-way valve 211.01: Secondary pump. Power control for high-efficiency pump on HE2/M2.
(R3 / N / PE)	211.01: Three-way valve
S1 / S1	Temperature sensor for collector
S2 / S2	Temperature sensor for storage tank 1
S3 / S3	Temperature sensor for storage tank 2
(S5 / S5)	211.01: Temperature sensor for collector feed
(S6 / S6)	211.01: Temperature sensor for storage tank feed
(S4 / S4)	Temperature sensor of the collector return line for the "Energy yield measurement" function

### Terminal assignment for hydraulic layout 210.02

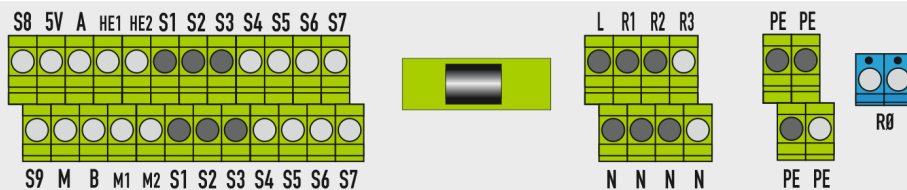
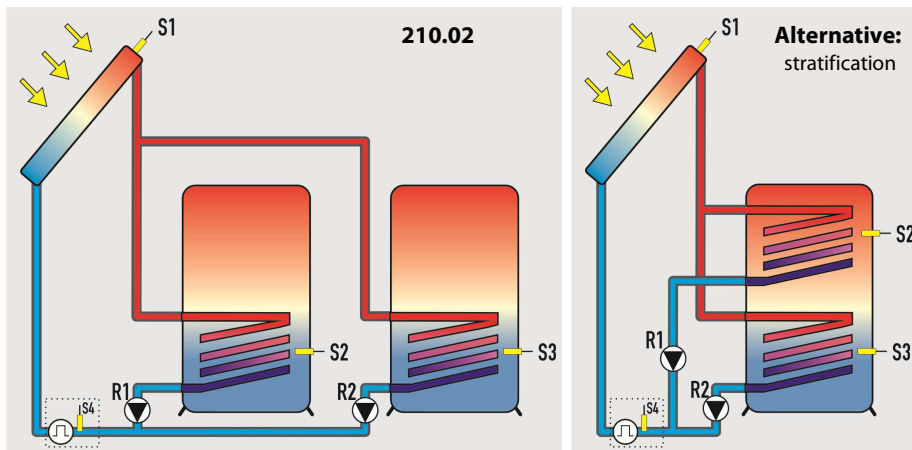

Terminal	Use
R1 / N / PE	Solar circuit pump, 230 V connection. Power control for high-efficiency pump on HE1/M1
R2 / N / PE	Solar circuit pump, 230 V connection. Power control for high-efficiency pump on HE2/M2
S1 / S1	Temperature sensor for collector
S2 / S2	Temperature sensor for storage tank 1
S3 / S3	Temperature sensor for storage tank 2
(S4 / S4)	Temperature sensor of the collector return line for the "Energy yield measurement" function

## Terminal assignment for hydraulic layouts 120.01, 121.01

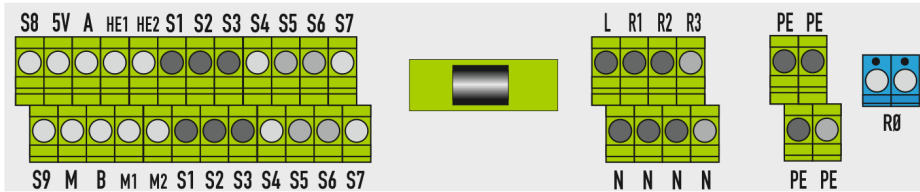
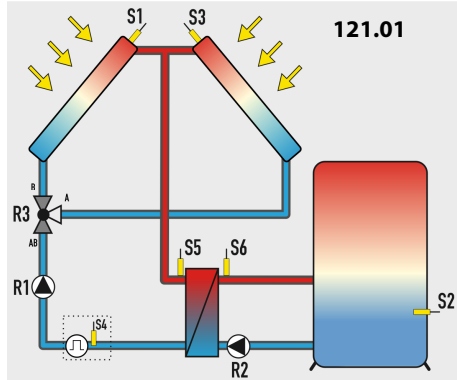
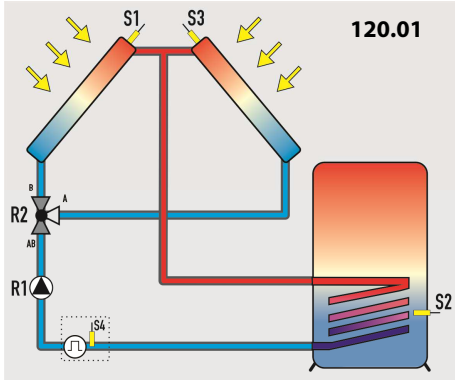

Terminal	Use
R1 / N / PE	Solar circuit pump, 230 V connection. Power control for high-efficiency pump on HE1/M1
R2 / N / PE	120.01: Three-way valve 121.01: Secondary pump. Power control for high-efficiency pump on HE2/M2
(R3 / N / PE)	121.01: Three-way valve
S1 / S1	Temperature sensor for collector 1
S2 / S2	Temperature sensor for storage tank
S3 / S3	Temperature sensor for collector 2
(S5 / S5)	121.01: Temperature sensor for collector feed
(S6 / S6)	121.01: Temperature sensor for storage tank feed
(S4 / S4)	Temperature sensor of the collector return line for the "Energy yield measurement" function

## Terminal assignment for hydraulic layout 120.02

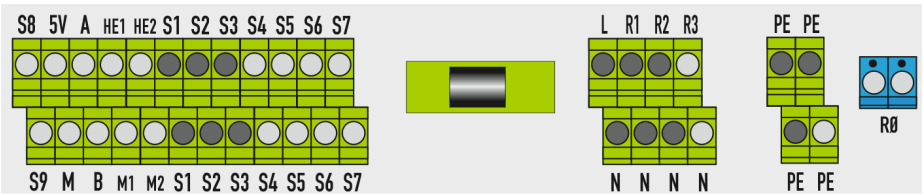
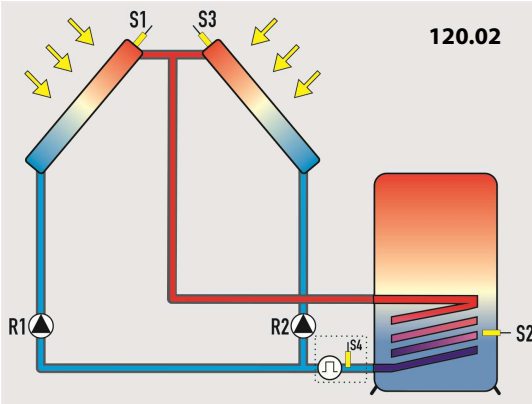

Terminal	Use
R1 / N / PE	Solar circuit pump, 230 V connection. Power control for high-efficiency pump on HE1/M1
R2 / N / PE	Solar circuit pump, 230 V connection. Power control for high-efficiency pump on HE2/M2
S1 / S1	Temperature sensor for collector
S2 / S2	Temperature sensor for storage tank 1
S3 / S3	Temperature sensor for storage tank 2
(S4 / S4)	Temperature sensor of the collector return line for the "Energy yield measurement" function

## Terminal assignment for hydraulic layout 000.00

In layout 000.00 you can use all outputs as multi-function controllers. In this case you must define at least one of the three switching outputs R1, R2 or R3 as a multi-function controller.





Terminal	Use
R1 / N / PE	Multi-function controller on switching output R1
R2 / N / PE	Multi-function controller on switching output R2
R3 / N / PE	Multi-function controller on switching output R3
R0	Multi-function controller on switching output R0 (potential-free normally open contact)
S1 / S1	Option: "Cooling", "Heating" or "Temperature difference controller" functions
S2 / S2	Option: "Cooling", "Heating" or "Temperature difference controller" functions
S3 / S3	Option: "Cooling", "Heating" or "Temperature difference controller" functions
S4 / S4	Option: "Cooling", "Heating" or "Temperature difference controller" functions
S5 / S5	Option: "Cooling", "Heating" or "Temperature difference controller" functions
S6 / S6	Option: Temperature display

## 6 Operating the controller

This chapter provides you with an overview of the controller's display elements and operating elements. This is followed by explanations of all the basic actions.

### 6.1 Description of the display elements

The main menu is located in the top part of the display. It is comprised of the following menus:

Main menu	
Symbol	Description
	<p><b>„Info“ menu</b> This is for displaying measurement and output values.</p>
	<p><b>„Program“ menu</b> This is for displaying and changing parameters.</p>
	<p><b>„Manual mode“ menu</b> This is for switching outputs on and off for test purposes. Only specialist personnel are permitted to make changes to the values in this menu</p>
	<p><b>„Basic settings“ menu</b> This is for displaying and changing basic settings. Only specialist personnel are permitted to make changes to the values in this menu.</p>

When you have selected a menu, the applicable menu symbol (1) will be displayed. The bottom section of the screen displays the value (3) complete with a corresponding addition (2) and a measurement value symbol (7). Below these, status information and messages may be displayed (4–6), depending on the specific menu item. The following illustration shows a display screen by way of illustration:

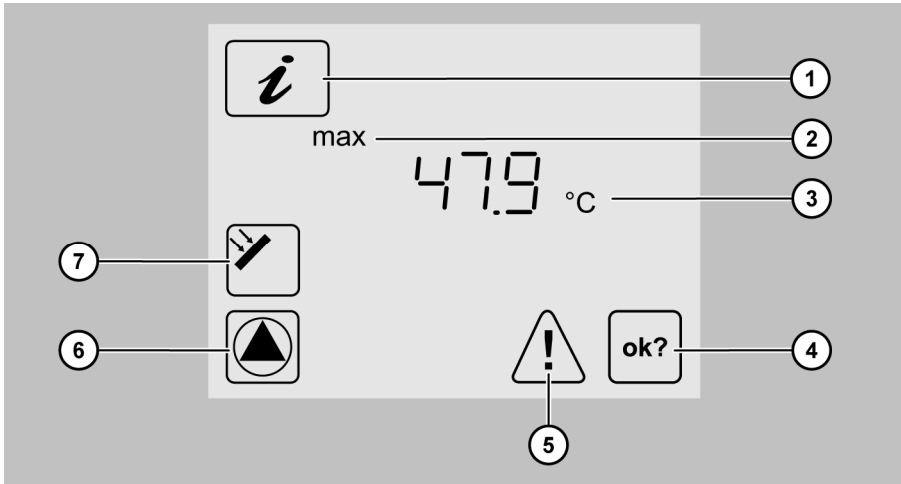

Pos.	Description
1	Active menu (In this case: "Info" menu)
2	Addition to the value displayed
3	Value
4	OK symbol. If you make any changes to a value, this symbol flashes.
5	Fault symbol. This symbol flashes in the event of a fault.
6	Pump symbol. This symbol rotates whenever the pump is switched on.
7	Measurement point symbol (In this case: Collector)







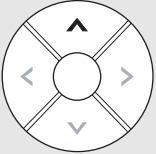
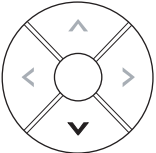
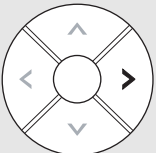
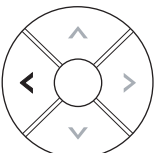

## 6.2 Using the operating buttons

The operating buttons allow you to navigate in the menus and make changes to values. The following table explains the functions of the operating buttons:

Operating buttons	Function
	Display the previous menu item. Increase the displayed value.
	Display the next menu item. Call up the selected menu. Reduce the displayed value.
	Scroll to the right in the main menu. Activate a menu item. The displayed value flashes. Confirm a change to a value.
	Scroll to the left in the main menu. Cancel the activation of a menu item. Any value changes that have not been confirmed will be discarded. The value that is currently set will be displayed. Return to the main menu. In the case of fault messages: Switch off the acoustic warning signal.

### Navigating in the menus

- To switch to the main menu, select .
- Use  or  to select the required menu. The selected menu symbol flashes.
- To display the various different menu items, select  or .
- To exit the menu, select .

## Changing values

- To activate the displayed menu item, select **>**.  
The value flashes.
- To increase the value, select **^**.
- To reduce the value, select **v**.
- To cancel the entry, select **<**.
- The value stops flashing. The value that is currently set will be displayed.
- To confirm the entry, select **>**.
- The value stops flashing. The OK symbol will be displayed.
- To cancel the entry, select **<**.
- The value that is currently set will be displayed.
- To re-confirm the entry, select **>**.

The OK symbol will no longer be displayed. Your entry has been adopted.

- ⓘ If you press the **^** or **v** buttons once, the value will be increased or reduced in steps. If you keep these buttons pressed, the value will be increased or reduced on a continuous basis.

# 7 Displaying and changing the values in the menus

This chapter provides an overview of the menus and menu items.



## 7.1 Displaying values in the "Info" menu



The "Info" menu allows you to display measurement and output values. Values that are marked by "x" in the "Reset" column can be reset.

- ⓘ Depending on which additional functions have been activated, not all values will necessarily be displayed.

„Info“ menu			
Example	Symbol	Description	Reset
75 °C		Current temperature of collector	–
min. 12 °C		Minimum temperature of collector	×
max. 105 °C		Maximum temperature of collector	×
75 °C			–
min. 12 °C			×
max. 105 °C			×
52 °C		Current temperature of storage tank	
min. 40 °C		Minimum temperature of storage tank	–
max. 67 °C		Maximum temperature of storage tank	×
60 °C		Current temperature of collector return	×
60 °C		"Heating", "Cooling", "Temperature difference controller" functions of a multi-function controller (In this case: R2) Sensor for the source (In this case: S5)	–
35 °C		"Heating", "Cooling", "Temperature difference controller" functions of a multi-function controller (In this case: R2) Sensor for the sink (In this case: S6)	–
25 °C		Display for the general temperature measurement point (hidden if not connected)	–
5 °C		Anti-freeze sensor (In this case: Sensor S1)	–
0,5 kW		Display: Radiation	–

„Info“ menu			
Example	Symbol	Description	Reset
1234 h		Operating hours for charging	To 0 h
8.4 l		Current flow	–
927 kWh		Energy output for the storage tank	To 0 kWh

To reset a value, proceed as follows:

➤ Select ➤ .

The OK symbol will be displayed.

Press ➤ to confirm. The value will be reset.

## 7.2 Displaying and changing values in the "Program" menu



The "Program" menu allows you to display and change the parameters. The "Current settings" column allows you to enter your settings.



### **WARNING**











Risk of scalding from hot water as a result of incorrect settings.















- Exercise particular care when configuring settings on the controller.
- Take water samples after completion of the settings and check them using a suitable thermometer.



### **ATTENTION**

Risk of system malfunctions due to incorrect settings.

- Set parameters only if you know their effects.

„Program“ menu					
Value	Symbol	Description	Range	Factory setting	Current setting
max. 65 °C		Storage tank: Required maximum temperature	15–95 °C	65 °C	
dT max 7 K		Storage tank: Switch-on-difference	3–40 K	7 K	
dT min 3 K		Storage tank: Switch-off-difference	2–35 K	3 K	
		If a hydraulic layout with several tanks has been selected in the "Basic settings" menu, the three previous menu items will be repeated for storage tank 2.			
0		Activate or deactivate storage tank with priority 2.	0 = active 1 = off	0 = active	
dT 30 K		Temperature difference for the "Parallel charging" function	10 K–40 K	30 K	
min 100 %		Minimum pump output with speed control. 100% = Speed control off.	30–100 %	100 %	
max 100 %		Maximum pump output with speed control.	30–100 %	100 %	
15 s		The time that the pump runs at the preset maximum output when switched on.	0–30 s	15 s	
min 40 °C		Target temperature for the collector. Only if "Target temperature" has been selected as the charging principle in the "Basic settings" menu.	15–85 °C	40 °C	
0,50 kW		Radiation: Value at which the "Tube collector" or "Drain-back" functions start. Only if the radiation-dependent controller has been activated for these functions in the "Basic settings" menu.	0–0,50 kW	0,10 kW	
13:21		Current time	00:00–23:59	12:00	
23:03:11		Current date			

	   	The following eight menu items apply to multi-function controllers R1, R2, R3 and R4. If a hydraulic layout has been selected in the "Basic settings" menu that allows for several multi-function controllers, these menu items will appear several times (once for each multi-function controller).			
min 100 %	 	Minimum pump output with speed control for the "Temperature difference controller" function 100% = Speed control off.	30–100 %	100 %	
min/max 40 °C		Switch-on temperature of the "Heating" and "Cooling" functions	20–90 °C	40 °C	
dT 10 K		Hysteresis of the "Heating" and "Cooling" functions	1–30 K	10 K	
max 65 °C		Maximum temperature Tmax of the sink for the "Temperature difference controller" function	15–95 °C	65 °C	
min 15 °C		Minimum temperature Tmin of the source for the "Temperature difference controller" function	0–95 °C	15 °C	
dT max 7 K		Switch-on difference dTmax for the "Temperature difference controller" function	3–40 K	7 K	
dT min 3 K		Switch-off difference dTmin for the "Temperature difference controller" function	2–35 K	3 K	
Start 00:00 1 (2, 3)		Time window 1 (2, 3): Start When the start time for the first time window has been defined, define the other time intervals in time windows 2 and 3	00:00–23:59	00:00	
Stop 23:59 1 (2, 3)		Time window 1 (2, 3): Stop When the stop time for the first time window has been defined, define the other time intervals in time windows 2 and 3	00:00–23:59	23:59	

The following menu items are applicable on a general basis:					
Start 06:00 4		Time window 4: Start for the "Tube collector" and "Drain-back" functions. Only if the time controller has been activated for these functions in the "Basic settings" menu.	00:00–23:59	6:00	
Stop 20:00 4		Time window 4: Stop for the "Tube collector" and "Drain-back" functions. Only if the time controller has been activated for these functions in the "Basic settings" menu.	00:00–23:59	20:00	
Sd: 1		Deactivate microSD card 0 = deactivated 1 = activated (automatic if a microSD card is inserted) This menu item will be displayed only if a microSD card has been inserted.	0–1	0	
Sd: L 60s		Data logging (data storage): Logging interval 1s = seconds: Data will be written every second. 60s = minutes: Data will be written every minute.	1 s 60 s	60 s	
AL:		Acoustic warning signal: 0 = inactive 1 = active	0–1	0	

## 7.3 Controlling switching outputs in the "Manual mode" menu







The "Manual mode" menu allows the controller's switching outputs to be turned on and off for test purposes. To enable the controller to run in automatic mode again, you have to exit manual mode after completion of setting tasks.

### **ATTENTION**

Risk of system malfunctions due to incorrect settings.

- Make sure that only specialist personnel ever make any changes to the values in this menu.

<b>"Manual mode" menu</b>		
<b>Symbol</b>	<b>Description</b>	<b>Current settings</b>
	Turning switching output R1 or HE1 on or off manually or controlling it with incremental power control (30%-90%)	0% = off 30% – 90 % 100% = on
	Turning switching output R2 or HE2 on or off manually or controlling it with incremental power control (30%-90%)	0% = off 30% – 90 % 100% = on
	Turning switching output R3 (pump or valve) on and off manually.	0% = off 30% – 100 %
	Turning switching output R0 (pump or valve) on and off manually.	0 = off 1 = on

## 7.4 Displaying and changing values in the "Basic settings" menu



The "Basic settings" menu allows you to display and change basic settings.

### ***ATTENTION***

Risk of system malfunctions due to incorrect settings.

- Make sure that users use only user mode.
- Make sure that the values are only ever changed by specialist personnel.

There are two operating modes:

- User mode
- Editing mode.

In user mode you can display values in this menu, but you cannot make any changes to them. If user mode is activated, the menu symbol is displayed in the form of a "locked" symbol.

In editing mode you can display and make changes to values in this menu. If editing mode is activated, the menu symbol is displayed in the form of an "unlocked" symbol. Only specialist personnel are permitted to activate editing mode.



- To activate editing mode, press the **▲**, **➤** and **▼** buttons simultaneously.

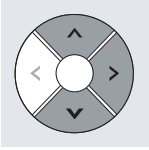







The menu symbol will be displayed in the form of an "unlocked" symbol. Editing mode will be active.



Note the following information in relation to the table on the menu items in the "Basic settings" menu:

- All higher-level positions are marked in **bold**. If these positions are not implemented in your system, the positions which follow them will not be displayed.
- Some positions appear only for certain system layouts.
- Positions marked by an asterisk \* contain further selection options. These are described after the table.
- The "Current settings" column allows you to enter your settings.

„Basic settings“ menu					
Position	Symbol	Description	Range	Factory settings	Current settings
<b>P:</b>		Hydraulic layout. When the hydraulic layout is changed, all the preset parameters and additional functions will be reset.	000.00–210.02	110.00	
P: 1:		Charging break Multi-tank systems only.	30–480 s	240 s	
P: 2:		Storage tank priority: 1 = Storage tank 1 2 = Storage tank 2	1–2	1	
P: 3:		Parallel charging: 0 = Off 1 = On	0–1	0	
<b>P: 4:</b>		Charging principle: 0 = Temperature difference 1 = Target temperature	0–1	0	
<b>P: 5:</b>		"Collector protection" function 0 = Off 1 = On 2 = "Drain-back" time-controlled function 3 = "Drain-Back" radiation-controlled function	0–3	0	
P: 6:		Collector protection temperature	110–150 °C	120 °C	
P: 7:		Pump runtime "Drain-back" function	15–360 s	180 s	

<b>„Basic settings“ menu</b>					
<b>Position</b>	<b>Symbol</b>	<b>Description</b>	<b>Range</b>	<b>Factory settings</b>	<b>Current settings</b>
<b>P: 8:</b>		"Recoiling" function 0 = Off 1 = On Only if the "Collector protection" function has been activated.	0–1	0	
P: 9:		Temperature to which the storage tank is recoiled. Only if the "Collector protection" and "Recoiling" functions have been activated.	30–90 °C	40 °C	
<b>P: 10:</b>		"Tube collector" function 0 = Off 1 = Time-controlled 2 = Radiation-controlled	0–2	0	
P: 11:		"Tube collector" function: Pump runtime	10–120 s	30 s	
<b>P: 12:</b>		Measurement principle for energy output measurement 0 = Off 1 = Flow sensor (DFG) 2 = VFS 3 = Flow indicator	0–3	0	
P: 13:		Pulse value of the flow sensor Unit: Litres per pulse. Only if the "Flow sensor" measurement principle has been activated.	0,5–25 L/l (in 0,5 litre increments)	1,0	
P: 14:		VFS type 0 = Type 1- 12 1 = Type 1- 15 2 = Type 1- 20 3 = Type 2- 40 4 = Type 5-100 5 = Type 10-200 6 = Type 20-400 Only if the "VFS" measurement principle has been activated.	0–6	2	
P: 15:		Flow rate for the "Flow indicator" measurement principle Unit: Litres per minute Only if the "Flow indicator" measurement principle has been activated.	0,1–75 litres/min (in 0,1 litre increments)	10,0 l	
P: 16:		Energy output measurement: Glycol type *	0–10	0	

„Basic settings“ menu					
Position	Symbol	Description	Range	Factory settings	Current settings
P: 17:		Energy output measurement: Glycol concentration	0–100 % (in 5 % increments)	50	
<b>P: 18:</b>		„Anti-freeze protection“ function 0 = Off 1 = On	0–1	0	
P: 19:		„Anti-freeze protection“ function: Selection of the sensor	1–6	6	
P: 20:		„Anti-freeze protection“ function: Start temperature	-20 – +7 °C	3 °C	
<b>P: 21:</b>		MFC R1 function at switching output R1 0 = Off 1 = Cooling 2 = Heating 3 = Return flow boost 4 = Temperature difference controller	0–4	0	
P: 22:		Selection of the sensor for the source for MFC R1	1–6	5	
P: 23:		Selection of the sensor for the sink for MFC R1	1–6	6	
<b>P: 24:</b>		MFC R2 function at switching output R2 0 = Off 1 = Cooling 2 = Heating 3 = Return flow boost 4 = Temperature difference controller	0–4	0	
P: 25:		Selection of the sensor for the source for MFC R2	1–6	5	
P: 26:		Selection of the sensor for the sink for MFC R2	1–6	6	
<b>P: 27:</b>		MFC R3 function at switching output R3 0 = Off 1 = Cooling 2 = Heating 3 = Return flow boost 4 = Temperature difference controller	0–4	0	
P: 28:		Selection of the sensor for the source for MFC R3	1–6	5	

„Basic settings“ menu					
Position	Symbol	Description	Range	Factory settings	Current settings
P: 29:		Selection of the sensor for the sink for MFC R3	1–6	6	
<b>P: 30:</b>		MFC R4 function at switching output R0 0 = Off 1 = Cooling 2 = Heating 3 = Return flow boost	0–3	0	
P: 31:		Selection of the sensor for the source for MFC R4	1–6	5	
P: 32:		Selection of the sensor for the sink for MFC R4	1–6	6	
<b>P: 33:</b>		Pump type on switching output R1 *	0–3	2	
<b>P: 34:</b>		Pump type on switching output R2 *	0–3	2	
<b>P: 35:</b>		Parameter management 0 = Current controller settings 1 = Restore factory settings 2 = Backup parameters from controller to microSD card 3 = Load parameters from microSD card to the controller Values 2 and 3 will be displayed only if a microSD card has been inserted.	0–3	0	
<b>P: 36:</b>		Firmware update 0 = Off 1 = Start update This menu item will be displayed only if a microSD card has been inserted.	0–1	0	
<b>P: 37:</b>		Selection from 0 = ProbusX , for working with conexio 200 1 = Modbus	0–1	0	
<b>P: 38:</b>		Modbus speed 0 = 9600 1 = 19200 2 = 57600 Baud	0–2	0	
<b>P: 39:</b>		Modbus address	1–247	2	

<b>* Position 16: Glycol types</b>			
<b>Selection</b>	<b>Meaning</b>	<b>Selection</b>	<b>Meaning</b>
0	Anro	6	Tyfocor L5.5
1	Ilexan E, Glythermin	7	Dowcal 10
2	Antifrogen L	8	Dowcal 20
3	Antifrogen N	9	Dowcal N
4	Ilexan E	10	Tyfocor LS
5	Ilexan P	11	Water

<b>* Positions 33 und 34: Pump types</b>	
<b>Selection</b>	<b>Meaning</b>
0	Standard pump, operated with alternating current (AC pump)
1	High-efficiency pump (HE pump) with analog control system
2	High-efficiency pump (HE pump) with PWM control system, characteristic not inverted
3	High efficiency pump (HE pump) with PWM control system, characteristic inverted

## 8 Setting the control functions

The general control functions allow you to configure the settings for the charging of the storage tanks. You can set the following control functions:

- Charging principle
- "Storage tank priority" function
- "Parallel charging" function
- Pump control
- "Tube collector" function.

### 8.1 Setting the charging principle

In order to optimise the energy output, you can choose from the following charging principles:

- "Temperature difference" charging principle
- "Target temperature" charging principle

The charging principle is selected in the "Basic settings" menu with the following value:

- P:4: Charging principle.

#### **"Temperature difference" charging principle"**

In the case of the "Temperature difference" charging principle, the solar circuit pump is controlled in such a way that the temperature difference between the collector and the storage tank is maintained at as constant a level as possible.

## "Target temperature" charging principle

In the case of the "Target temperature" charging principle, the solar circuit pump is switched on when a certain specific target temperature has been reached in the collector.

The "Program" menu allows you to set the following parameter:

- Target temperature for the collector.

## 8.2 Setting the "Storage tank priority" function

 This function is available only for hydraulic layouts 210.01 and 210.02.

The "Storage tank priority" function controls the tank charging of dual tank systems. There are the following types of dual tank systems:

- Systems with two separate storage tanks
- Systems with a stratified storage tank (a storage tank with two heat exchangers, one on top of the other)
- Systems with a storage tank in combination with a swimming pool
- etc.

In control mode, the first storage tank is charged as a storage tank with priority 1. If more heat is generated than required, the excess energy is fed into the second storage tank (storage tank with priority 2). In the case of the stratified storage tank, the top heat exchanger is defined as the second storage tank.

The "Basic settings" menu allows you to set the following parameters:

- P:0: Hydraulic layout
- P:1: Charging break
- P:2: Storage tank priority

The "Program" menu allows you to set the following parameters:

- Activate or deactivate storage tank with priority 2.

## 8.3 Setting the "Parallel charging" function

 This function is available only for hydraulic layout 210.02.

If the preset temperature difference of the two storage tanks is exceeded and if the switch-on conditions for the low priority storage tank are met, both storage tanks will be charged simultaneously. Both pumps run with a pump output of 100 %. The energy output is divided between the two storage tanks.

The "Basic settings" menu allows you to set the following parameters:

- P:0: Hydraulic layout
- P:3: Parallel charging

The "Program" menu allows you to set the following parameter:

- Temperature difference for the "Parallel charging" function.

## 8.4 Setting the pump control system

You can connect standard pumps and high-efficiency pumps (HE pumps). For these you can set the following types of control system:

- 230 V block modulation (standard pumps)
- Analog control (HE pumps)
- Non-inverted PWM control (HE pumps)
- Inverted PWM control (HE pumps)

The "Basic settings" menu allows you to set the following parameters:

- P:33: Pump control on switching output R1
- P:34: Pump control on switching output R2

In order to keep the storage tank temperature as constant as possible, the solar circuit pumps can be controlled by means of speed control. You can set the minimum pump output with speed control between 30 % and 100 %. At 100 % the speed control will be switched off.

The "Program" menu allows you to set the following parameter:

- Minimum pump output with speed control.

 Switching outputs R1 and R2 switch only the pump supply. They are not speed-controlled. Your minimum switch-on time is 5 seconds.

### Setting the pump speed control

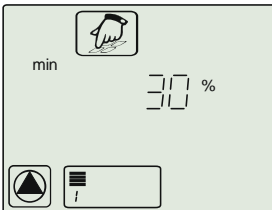

Minimum pump output with speed control.

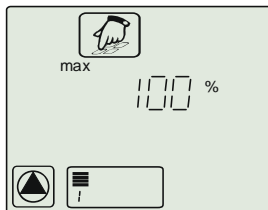

Maximum pump output with speed control.

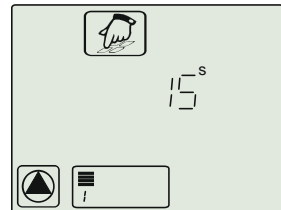

The time that the pump runs at the preset maximum output when switched on.

### Controlling HE pumps with analog signals

In the case of the pump control system complete with analog signal, the controller sends a 0–10 V analog signal to terminals HE1 and HE2.

Definitions for the output voltage (U):

- Pump off:  $0.5 \text{ V} < U < 1.0 \text{ V}$
- Speed control: Linear characteristic  $3 \text{ V} < U < 10 \text{ V}$  (for a minimum pump output of 30 %)

The following diagram shows the power curve for the pump control system with analog signal.

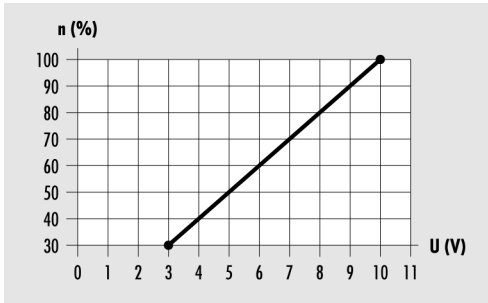

n (%) – Pump output U

(V) – Output voltage

### Controlling HE pumps with PWM signals

In the case of the pump control system with PWM signal, the controller sends a PWM signal (pulse width modulation signal) to terminals HE1 and HE2. The PWM signal can be sent normally (not inverted) or inverted.

#### Not inverted

In the case of the pump control system with a non-inverted PWM signal, the nominal speed of the pump (0–100 %) corresponds to the PWM signal (0–100 %). The following diagram shows the power curve for the pump control system with a non-inverted PWM signal.

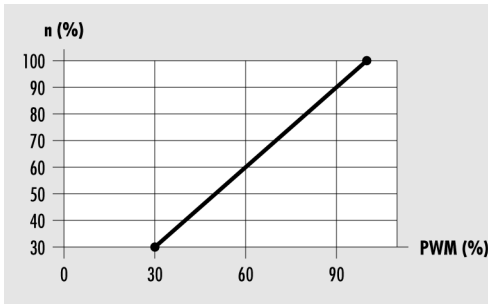

n (%) – nominal speed of the pump

PWM (%) – non-inverted PWM signal

#### Inverted

In the case of the pump control system with an inverted PWM signal, the nominal speed of the pump (0–100 %) corresponds to the PWM signal (100–0 %). The following diagram shows the power curve for the pump control system with an inverted PWM signal at a minimum pump output of 30 %.



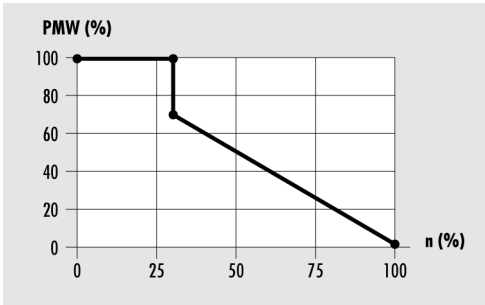

PMW (%) – inverted PWM signal

n (%) – pump speed sent by the controller

## 8.5 Setting the "Tube collector" functions

If the solar power system is equipped with tube collectors, you have to activate this function.

The control type is selected in the "Basic settings" menu with the following value:

- P:10: "Tube collector" function
  - Time-controlled
  - Radiation-controlled.

### Time-controlled

You can set a time window and a pump runtime. In the time window the solar circuit pump is switched on at certain specific intervals for the duration of the preset pump runtime.

The "Basic settings" menu allows you to set the following parameters:

- P:11: "Tube collector" function: Pump runtime.

The "Program" menu allows you to set the following parameters:

- Time window 4: Start for the "Tube collector" and "Drain-back" functions
- Time window 4: Stop for the "Tube collector" and "Drain-back" functions

### Radiation-controlled

When the level of radiation reaches the preset radiation value, the solar circuit pump is switched on for the duration of the preset pump runtime.

The "Basic settings" menu allows you to set the following parameters:

- P:11: "Tube collector" function: Pump runtime.

The "Program" menu allows you to set the following parameter:

- Radiation: Value at which the "Tube collector" or "Drain-back" functions start.

## 9 Setting multi-function controllers (MFC)

Depending on the hydraulic layout, switching outputs R0, R1, R2 and R3 can be used as multi-function controllers (MFC). These can be set irrespective of the basic functions of the controller.

You can assign the following functions to the multi-function controllers:

- "Cooling" function
- "Heating" function
- "Return flow boost" function
- "Temperature difference controller" function.

**i** You can set the parameters of the multi-function controllers in the "Basic settings" menu with the values P:21: to P:32: . The following provides a description of the settings using multi-function controller R3 by way of illustration.

### 9.1 Setting the "Cooling" function

In the case of the "Cooling" function, the switching output of the multi-function controller switches on as soon as the preset switch-on temperature is exceeded. If the temperature drops below the lower limit of the preset temperature range (hysteresis), the switching output of the multi-function controller switches off.

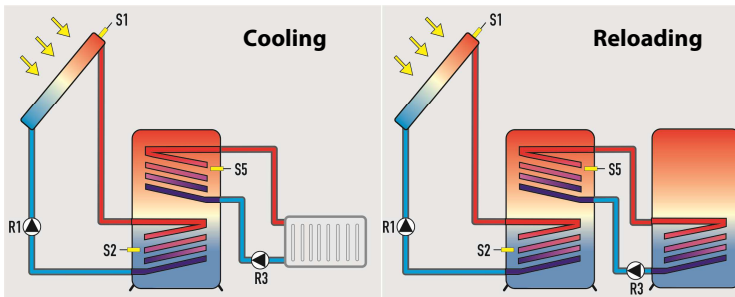

The "Basic settings" menu allows you to set the following parameters:

- P:27: MFC R3 function at switching output R3
- P:28: Selection of the sensor for the source for MFC R3

The "Program" menu allows you to set the following parameters:

- Switch-on temperature of the "Heating" and "Cooling" functions
- Hysteresis of the "Heating" and "Cooling" functions
- Time window 1 (2, 3): Start
- Time window 1 (2, 3): Stop.

## 9.2 Setting the "Heating" function

In the case of the "Heating" function, the switching output of the multi-function controller switches on as soon as the temperature falls below the preset switch-on temperature. If the temperature rises above the upper limit of the preset temperature range (hysteresis), the switching output of the multi-function controller switches off.

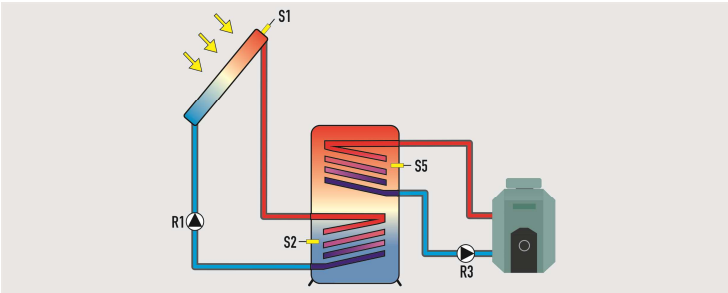

The "Basic settings" menu allows you to set the following parameters:

- P:27: MFC R3 function at switching output R3
- P:28: Selection of the sensor for the source for MFC R3

The "Program" menu allows you to set the following parameters:

- Switch-on temperature of the "Heating" and "Cooling" functions
- Hysteresis of the "Heating" and "Cooling" functions
- Time window 1 (2, 3): Start
- Time window 1 (2, 3): Stop.

## 9.3 Setting the "Return flow boost" function

To save energy, energy is supplied to the heating return flow from the solar circuit or storage tank. The mode of operation and relevant parameters are similar to those of the "Temperature difference controller" function.

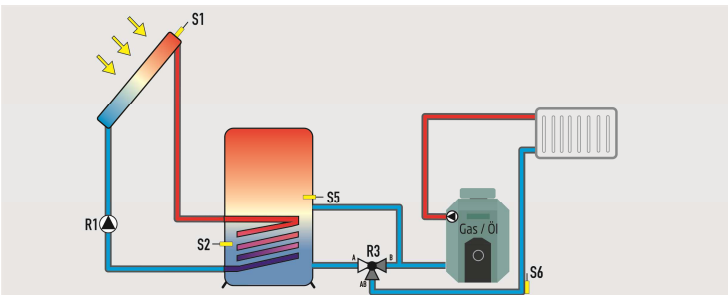

The "Basic settings" menu allows you to set the following parameters:

- P:27: MFC R3 function at switching output R3
- P:28: Selection of the sensor for the source for MFC R3
- P:29: Selection of the sensor for the sink for MFC R3

The "Program" menu allows you to set the following parameters:

- Maximum temperature  $T_{max}$  of the sink for the "Return flow boost" function
- Minimum temperature  $T_{min}$  of the source for the "Return flow boost" function
- Switch-on difference  $dT_{max}$  for the "Return flow boost" function
- Switch-off difference  $dT_{min}$  for the "Return flow boost" function
- Time window 1 (2, 3): Start
- Time window 1 (2, 3): Stop.

### 9.4 Setting the "Temperature difference controller" function

In the case of the "Temperature difference controller" there is a measurement point at both the source and the sink. If the difference between the temperatures of the two measurement points exceeds a predefined value, the switching output of the multi-function controller switches on.

In addition, a minimum temperature can be set at the source and a maximum temperature at the sink. If the maximum temperature is exceeded or the temperature falls below the minimum temperature, the switching output of the multi-function controller switches off.

The "Basic settings" menu allows you to set the following parameters:

- P:27: MFC R3 function at switching output R3
- P:28: Selection of the sensor for the source for MFC R3
- P:29: Selection of the sensor for the sink for MFC R3

The "Program" menu allows you to set the following parameters:

- Maximum temperature  $T_{max}$  of the sink for the "Temperature difference controller" function
- Minimum temperature  $T_{min}$  of the source for the "Temperature difference controller" function
- Switch-on difference  $dT_{max}$  for the "Temperature difference controller" function
- Switch-off difference  $dT_{min}$  for the "Temperature difference controller" function
- Time window 1 (2, 3): Start
- Time window 1 (2, 3): Stop.

## 10 Setting protective functions

In order to protect the solar power system against frost and overheating, the controller is equipped with the following protective functions:

- "Collector protection" function
- "Storage tank protection" function
- "System protection" function
- "Recooling" function
- "Drain-back" function
- "Anti-freeze protection" function.

### 10.1 Setting the "Collector protection" function

This function protects the collector against overheating. If the preset collector protection temperature is exceeded, the solar circuit pump switches on. The pump runs until the temperature limit in the storage tank (95 °C) has been reached. This is done irrespective of the preset maximum storage tank temperature.

If the temperature of the collector falls below the preset collector protection temperature by 10 °C, the solar circuit pump switches off. The system will run again in normal operating mode.

The "Basic settings" menu allows you to set the following parameters:

- P:5: "Collector protection" function
- P:6: Collector protection temperature.

### 10.2 "Storage tank protection" function

 If a hydraulic layout with two storage tanks is used, the "Storage tank protection" function will be automatically active and cannot be changed.

This function protects the storage tanks against overheating caused by faulty wiring or any other possible faults. If the temperature limit is exceeded in one of the storage tanks (95 °C), all switching outputs will be switched off. The storage tank will no longer be charged.

When the temperature in the storage tank falls below the temperature limit again, the system will be in normal operating mode again.

### 10.3 "System protection" function

 The "System protection" function is active at all times and cannot be changed.

If the temperature of the collector exceeds the system protection temperature (collector protection temperature + 10 °C), the "System protection" function will be triggered. The solar circuit pump switches off.

When the temperature falls below the system protection temperature, the system will be in the "Collector protection" function again. When the temperature falls below the collector protection temperature, the system will be in normal operating mode.

## 10.4 Setting the "Recooling" function

---

### ***ATTENTION***

Risk of damage to the solar power system if operated with the "Recooling" function in combination with reheating.

- Make sure that reheating is not in operation before you activate the "Recooling" function.

---

 The "Recooling" function can be activated only if the "Collector protection" function is active.

This function protects the system against overheating in the following situations:

- If no hot water is used over an extended period of time (e. g. during a vacation)
- If the collector protection temperature is exceeded

If the temperature in the collector falls below the temperature in the storage tank (usually at night), the solar circuit pump switches on. This reools the storage tank to a preset temperature.

The "Basic settings" menu allows you to set the following parameters:

- P:5: "Collector protection" function
- P:6: Collector protection temperature
- P:8: "Recooling" function
- P:9: Temperature to which the storage tank is reooled.

## 10.5 Setting the "Drain-back" function

 The "Drain-back" function can be activated only if the "Recooling" function has been deactivated.

The "Drain-back" (return flow) function protects the solar power system against overheating and frost. This function requires the installation of a collection tank. When the solar circuit pump is switched off, heat transfer fluid flows back into the collection tank. In the process, the heat transfer fluid is cooled down or heated up.

When the solar circuit is switched back on, it will initially run for the duration of the preset pump runtime with full pump output. Afterwards the solar circuit pump will then run in normal operating mode again.

The "Basic settings" menu allows you to set the following parameters:

- P:6: Collector protection temperature
- P:7: Pump runtime "Drain-back" function

The control type is selected in the menu "Basic settings" with the following value:

- P:5: "Collector protection" function
  - "Drain-back" time-controlled function
  - "Drain-back" radiation-controlled function

## Time-controlled

You can set a time window and a pump runtime. In the time window the solar circuit pump is switched on at certain specific intervals for the duration of the preset pump runtime.

The "Basic settings" menu allows you to set the following parameters:

- P:6: Collector protection temperature
- P:7: Pump runtime "Drain-back" function

The "Program" menu allows you to set the following parameters:

- Time window 4: Start for the "Tube collector" and "Drain-back" functions
- Time window 4: Stop for the "Tube collector" and "Drain-back" functions

## Radiation-controlled

When the level of radiation reaches the preset radiation value, the solar circuit pump is switched on for the duration of the preset pump runtime.

The "Basic settings" menu allows you to set the following parameters:

- P:6: Collector protection temperature
- P:7: Pump runtime "Drain-back" function

The "Program" menu allows you to set the following parameter:

- Radiation: Value at which the "Tube collector" or "Drain-back" functions start.

## 10.6 Setting the "Anti-freeze protection" function

 The "Anti-freeze protection" function can be activated only if the "Drain-back" function has been deactivated.

This function protects the solar power system against the heat transfer fluid freezing. If the temperature falls below the preset temperature, the solar circuit pump switches on.

If the preset temperature is exceeded, the solar circuit pump switches off. The system will run again in normal operating mode.

The "Basic settings" menu allows you to set the following parameters:

- P:18: "Anti-freeze protection" function
- P:19: "Anti-freeze protection" function: Selection of the sensor
- P:20: "Anti-freeze protection" function: Start temperature.

# 11 Measuring energy output

The controller can calculate and display the energy output of the solar power system. To do so, it requires the following values:

- Flow rate
- Temperature difference between the collector and collector return flow temperatures
- Glycol type and glycol concentration in the heat transfer fluid

The energy output (kWh) is displayed in the "Info" menu in the following menu item:

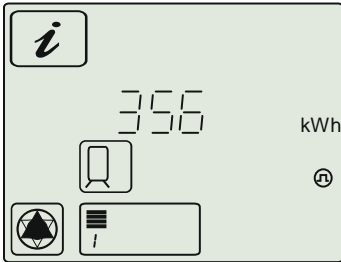

You can set the following measurement principles:

- Flow sensor (DFG)
- VFS (Vortex Flow Sensor)
- Flow indicator.

## 11.1 Flow sensor (DFG)

The flow sensor measures the flow rate mechanically. It is located on the return flow pipe of the solar power system. To determine the energy output with a flow sensor, the pipe-mounted sensor S4 must also be connected for temperature measurement.

## 11.2 VFS (Vortex Flow Sensor)

The VFS measures the flow rate and the temperature. The following types can be installed in the solar power system:

VFS Type 1- 12, VFS Type 1- 15, VFS Type 1- 20, VFS Type 2- 40, VFS Type 5-100, VFS Type 10-200, VFS Type 20-400.

## 11.3 Flow indicator

In the case of this measurement principle the flow rate is measured just the once by a flow indicator (or adjustment valve) at a pump output of 100 %. The measurement value is entered at the controller. The flow indicator can then be removed again. The energy output is determined on the basis of this measurement value.



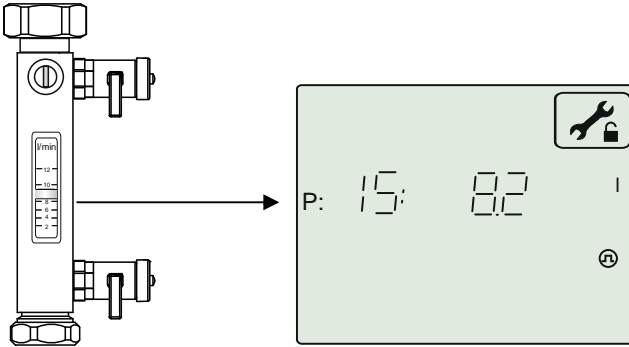

## 11.4 Setting the energy output measurements

The "Basic settings" menu allows you to set the following parameters:

- P:12: Measurement principle for energy output measurement
- P:13: Pulse value of the flow sensor
- P:14: VFS type
- P:15: Flow rate for the "Flow indicator" measurement principle
- P:16: Energy output measurement: Glycol type
- P:17: Energy output measurement: Glycol concentration.

## 12 Restore factory settings

### ***ATTENTION***

Risk of loss of current settings due to incorrect restoration of the factory settings.

- Before restoring the factory settings, make sure that you no longer require the current settings.
- If necessary, save the current settings to a microSD card before restoring the factory settings.

The factory settings are the parameters that were preset ex works.

- In order to restore the factory settings, select the value "1" in the "P: 35:" menu item in the "Basic settings" menu.

The factory settings will be restored.

## 13 Networking the controller with other devices

The RS-485 interface (ProBusX) allows you to connect the controller to other devices in a network. By networking (with the conexio 200 web module) you can use the following additional functions via a PC, tablet PC, smartphone etc.:

- Viewing the controller's data on another device (monitoring)
- Operating the controller from another device (remote control)

The manufacturer can provide further details.

## 14 Faults

---

### ***ATTENTION***

Risk of damage to the system if faults are remedied incorrectly.

- Make sure that faults are only ever remedied by specialist personnel.
- 

There are two categories of system faults:

- Faults that are detected by the controller and trigger a fault message
- Faults that are not detected by the controller and do not trigger a fault message.

### 14.1 Faults with fault message

In the event of faults with fault messages, the fault symbol will start flashing in the bottom part of the display. An acoustic warning signal will also be sounded if the "Acoustic warning signal" function is active.

- To switch off the acoustic warning signal, press the ◀ operating button.

The acoustic warning signal will fall silent.

### **Activating and deactivating the acoustic warning signal**

You can specify whether an acoustic warning signal is to be sounded or not in the event of a fault message.

- To activate the acoustic warning signal, select the value "1" in the "AL" menu item in the "Program" menu.

The acoustic warning signal will be active.



- To deactivate the acoustic warning signal, select the value "0" in the "AL" menu item in the "Program" menu.

The acoustic warning signal will be inactive.

### **Displaying fault messages**

- To display the fault message, go to the "Info" menu.
- Use the operating buttons ▼ and ▲ to navigate until the fault message is displayed.

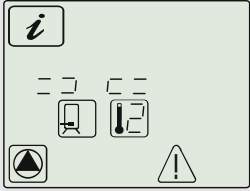
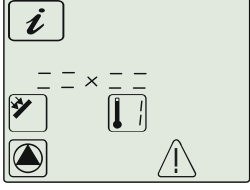
The table below shows the faults with fault messages:

Fault message	Possible cause	Action
 <p data-bbox="127 408 236 440">! flashing</p>	<p data-bbox="432 201 676 248">A sensor line is interrupted. Here S2</p>	<p data-bbox="736 201 1014 248">Make sure that the sensor lines are intact.</p>
	<p data-bbox="432 280 586 296">A sensor is faulty.</p>	<p data-bbox="736 280 1003 328">Check the sensor resistance. If necessary, replace the sensor.</p>
 <p data-bbox="127 676 236 708">! flashing</p>	<p data-bbox="432 469 698 517">A short circuit has occurred in the sensor line. Here S1.</p>	<p data-bbox="736 469 1014 517">Make sure that the sensor lines are intact.</p>
 <p data-bbox="127 944 266 976">! flashing</p> <p data-bbox="127 984 398 1080">Circulation fault: No flow The controller does not switch off the pump in this case!</p>	<p data-bbox="432 737 705 785">A fault has occurred in a pump connection.</p>	<p data-bbox="736 737 960 785">Make sure that the pump wiring is intact.</p>
<p data-bbox="127 1107 349 1139">A sensor line is faulty.</p>	<p data-bbox="432 1107 705 1155">A fault has occurred in a pump connection.</p>	<p data-bbox="736 1107 1014 1155">Make sure that the sensor lines are intact.</p>
<p data-bbox="127 1187 349 1219">A pump is faulty.</p>	<p data-bbox="432 1187 705 1235">A pump is faulty.</p>	<p data-bbox="736 1187 902 1235">Replace the pump.</p>
<p data-bbox="127 1267 349 1299">There is air in the system.</p>	<p data-bbox="432 1267 658 1299">There is air in the system.</p>	<p data-bbox="736 1267 889 1299">Vent the system.</p>
<p data-bbox="127 1445 392 1493">Energy output measurement: No flow is detected</p>		

## 14.2 Faults without fault message

The table below shows the faults without fault messages:

Fault	Possible cause	Action
No indication on the display.	There is no mains voltage.	Switch on the controller or connect the controller to the mains voltage.
		Make sure that the main fuse for the mains connection is switched on.
	The controller's fuse is faulty.	If necessary, replace the controller's fuse. Use a type 2A/T fuse.
		Check the 230 V components for a short circuit. In the event of a short circuit, contact the manufacturer.
The pump fails to switch on.	Manual mode has been activated.	Exit manual mode.
	The preconditions for the pump to be switched on have not been met.	Wait until the preconditions for the pump to be switched on have been met.
	The temperature limit for a storage tank (95 °C) has been exceeded.	Make sure that the wiring is intact. Make sure that the system components are intact.

<b>Fault</b>	<b>Possible cause</b>	<b>Action</b>
The pump symbol rotates without the pump actually running.	The connection to the pump has been interrupted.	Make sure that the cable connection to the pump is intact.
	The pump has seized up.	Make sure that the pump is running.
	There is no voltage at the pump output.	Contact the manufacturer.
The temperature display fluctuates strongly at short intervals.	The sensor lines have been installed close to 230 V lines.	Install the sensor lines at the greatest possible distance from the 230 V lines. Make sure that the sensor lines are shielded.
	The extensions of the sensor lines have not been shielded.	Make sure that the sensor lines are shielded.
	The controller is faulty.	Contact the manufacturer.

# 15 Technical data

<b>Autonomous electronic temperature difference controller, continuous operation</b>	
Housing material	100% recyclable ABS housing
Dimensions L x W x D in mm	176 × 162 × 44
Protection class	IP30 according to DIN 40050, EN 60529
Operating voltage	AC 230 voltage, 50 Hz, -10 to +15%
Standby power consumption	0,8 W
Max. line cross-section for 230 V connections	2.5 mm <sup>2</sup> finely stranded/single core
Inputs S1–S6 (protected by varistors)	For temperature sensors PT 1000 (1 kΩ at 0 °C)
Input S7	For radiation sensor type PSF
Other inputs	VFS (vortex flow sensor) DFG (impeller flow sensor)
Measuring range (temperature)	-30 °C to +250 °C
Interfaces	RS 485 for ProBusX
Output R1–R3	Electronic semiconductor relay (Triac) with zero-cross switch, opto-decoupled, 230 V AC, 50 Hz, min. 10 mA, max. 150 W, with $\cos \varphi \geq 0.9$
Total output of all outputs	Max. 300 W
Output R0	Relay, potential-free normally open contact, max. 250 V AC / 1 A, also suitable for protective extra-low voltage
Control output for HE pump	PWM signal: 1kHz, $V_{iL} < 0.5$ V DC, $V_{iH} > 9$ V DC, 10 mA max. Analog signal: 0 ... +10 V DC +/- 3%, 10 mA max.
Display	Backlit LCD display
Type 1 action	Type 1.B and type 1.Y
Software class	A
Protection	Microfuse 5 × 20 mm, 2 A/T (2 ampere, slow)
Ambient temperature	0 to +40 °C
Storage temperature	-10 to +60 °C

## 16 Resistance table

With reference to the table below check the functioning of the temperature sensors using a resistance meter:

Temperature in °C / Resistance in ohms							
-10 °C	0 °C	10 °C	20 °C	40 °C	60 °C	80 °C	100 °C
960 Ω	1000 Ω	1039 Ω	1078 Ω	1155 Ω	1232 Ω	1309 Ω	1385 Ω

## 17 Accessories

The following accessories are available for this controller:

- microSD card
- conviso software
- conexio web module 200.



Use only microSD cards from the manufacturer. The manufacturer cannot provide a guarantee that any other microSD cards will work.

The conviso software allows you to display the data stored on the microSD card on a standard commercially available PC.

The conexio web module allows you to display the controller's data on another system (monitoring) via the Internet. In addition, it allows you to operate the controller from another system (remote control) via the Internet. The conexio web module can be obtained from the manufacturer.

The following accessories are available for the solar power system:

- Temperature sensor PT1000
- Output measurement set (incl. pipe contact sensor)
- Sensor connection box (additional surge protection against indirect lightning)
- Immersion sleeves.

## 18 Disposing of the controller

The environmentally-friendly disposal of electronic assemblies, recyclable materials and other unit components is regulated by national and regional laws.

- Contact the competent local authority for detailed information on disposal.
- Dispose of lithium batteries in accordance with the statutory regulations.
- Dispose of all components in accordance with statutory regulations.











These instructions were prepared by a technical documentation office certified by DocCert-System.



## **Address of manufacturer**

Prozeda GmbH

In der Büg 5

D-91330 Eggolsheim

Telephone: +49(0)9191/6166-0

Telefax: +49(0)9191/ 6166-22

Email: kontakt@prozeda.de

[www.prozeda.de](http://www.prozeda.de)

1334B-TB001-14B-E