



LOW PRESSURE CENTRIFUGAL FANS

CBP Series

Complete low pressure centrifugal range with forward curved impeller. The range comprises different versions and sizes of double and single inlet fans. All these low pressure centrifugal fans are designed for belt drive operation.

All the fans are manufactured from **galvanised sheet steel** and fitted with impeller manufactured from galvanized sheet steel.

Additional Information

Mounting feet as accessory allowing 4 different positions (basic version).

The fan can be supplied with motor and belt drive mounted.

On request

Belt-drive fan-deck assemblies available with either a fan scroll or separate base frame mounted motor configurations.

A P P L I C A T I O N S



Incorporation in ventilation cabinets

High robustness



One piece die-cast ball bearing support

Impeller dynamically balanced



Impeller dynamically balanced, according to ISO 1940 standard, providing vibration free operation

P O S I T I O N S

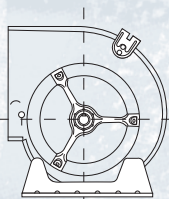

LG 90

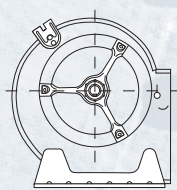

LG 270

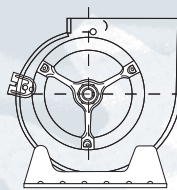

LG 0

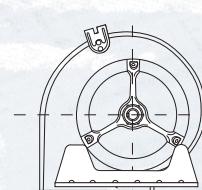

LG 180

Mounting feet (accessory) allowing 4 positions of the discharge outlet.

CBP

Low pressure centrifugal fans

■ Technical characteristics

Before installation check that the product electrical characteristics listed on the data plate label (Voltage, power, frequency etc) match those of the intended electrical supply.

Model	Equivalence (mm)	Maximum speed recommended (r.p.m.)	Maximum airflow (m³/h)	Weight (kg)
CBP-7/7	180/180	2400	2800	5
CBP-9/7	240/180	2400	6000	8
CBP-9/9	240/240	2200	7000	9
CBP-10/8	270/200	1800	6500	10
CBP-10/10	270/270	1800	7900	11
CBP-12/9	320/240	1600	8000	14
CBP-12/12	320/320	1400	10000	16
CBP-15/11	380/280	1300	12500	20
CBP-15/15	380/380	1200	16000	23
CBP-18/13	460/330	1000	18500	28
CBP-18/18	460/460	1000	22000	33

■ Dimensions (mm)

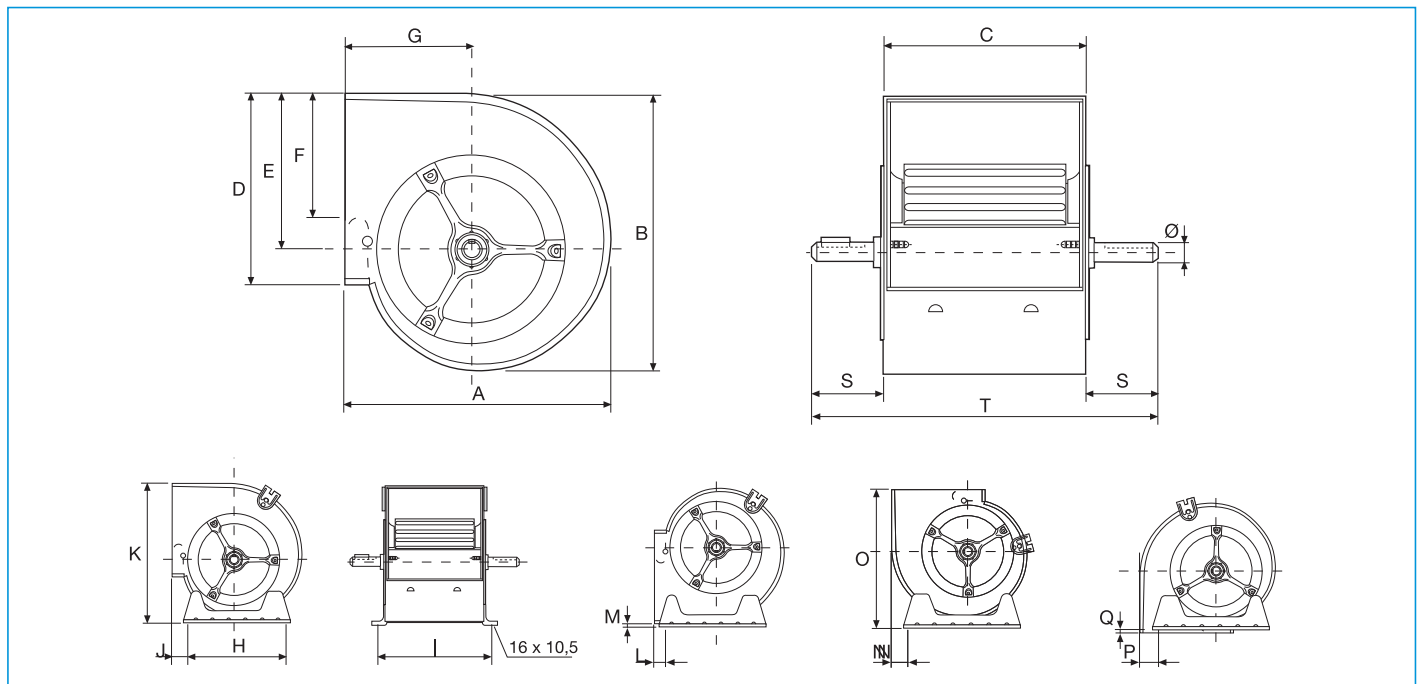

Model	A	B	C	D	E	F	G	H	I	J	K	L	M	N	O	P	Q	S	T	Ø
CBP-7/7	307	321	232	222	180	148	146	227	259	20,6	329,3	17,5	4,5	32	309,5	14,5	4,7	49	330	20
CBP-9/7	380	392	232	260	218	180	184	296	259	68,5	395,5	68,5	39	34,5	382	34,5	6	79	390	20
CBP-9/9	380	392	300	260	218	180	184	296	327	68,5	395,5	68,5	39	34,5	382	34,5	6	60	420	20
CBP-10/8	422	441	266	289	247	213	201	339	293	67	450,5	67	40	39	427	39	8	62	390	20
CBP-10/10	422	441	333	289	247	213	201	339	360	67	450,5	67	40	39	427	39	8	63,5	460	20
CBP-12/9	493	524	311	341	293	240	229	407	338	69,5	528	69,5	38,4	40,5	496,4	41,4	4,5	59,5	430	25
CBP-12/12	493	524	396	341	293	240	229	407	423	69,5	528	69,5	38,4	40,5	496,4	41,4	4,5	70	536	25
CBP-15/15	573	613	473	403	343	270	267	494	499,5	62,5	625	68,5	37	44,5	575	48,5	8	71	615	25
CBP-18/18	685	743	556	479	418	290	314	608	585	44,2	751	52,5	44	91,4	689,4	91,4	4,6	68	692	25

■ Mounting accessories

Model	Motor support tightener	Mounting feet
CBP-7/7	Soporte Motor Tensor 7/7 - 9/7	PIE SOPORTE CBP 7/7
CBP-9/7	Soporte Motor Tensor 7/7 - 9/7	PIE SOPORTE CBP/CBM 9/9
CBP-9/9	Soporte Motor Tensor 9/9	PIE SOPORTE CBP/CBM 9/9
CBP-10/8	Soporte Motor Tensor 10/8	PIE SOPORTE CBP/CBM 10/10
CBP-10/10	Soporte Motor Tensor 10/10	PIE SOPORTE CBP/CBM 10/10
CBP-12/9	Soporte Motor Tensor 12/9	PIE SOPORTE CBP/CBM 12/12

Model	Motor support tightener	Mounting feet
CBP-12/12	Soporte Motor Tensor 12/12	PIE SOPORTE CBP/CBM 12/12
CBP-15/11	Soporte Motor Tensor 15/11	PIE SOPORTE CBP/CBM 15/15
CBP-15/15	Soporte Motor Tensor 15/15	PIE SOPORTE CBP/CBM 15/15
CBP-18/13	Soporte Motor Tensor 18/13	PIE SOPORTE CBP/CBM 18/18
CBP-18/18	Soporte Motor Tensor 18/18	PIE SOPORTE CBP/CBM 18/18

■ Dimensions accessories (mm)



Mounting feet

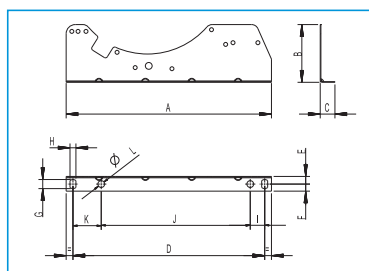

Model	A	B	C	D	E	F	G	H	I	J	K	L
7/	254	47	26	227	13,5	12,5	16	10,5	15	195	15	12
9/	325	102	26	297	13,5	12,5	16	10,5	-	-	35,7	10,5
10/	363	102	26	339	13,5	12,5	16	10,5	37,5	263,5	62	12
12/	434	144	26	407	13,5	12,5	16	10,5	48	333,5	25,5	12
15/	521	164	26	494	13,5	12,5	16	10,5	-	-	53	12
18/	635	186	26	608	13,5	12,5	16	10,5	-	-	-	-

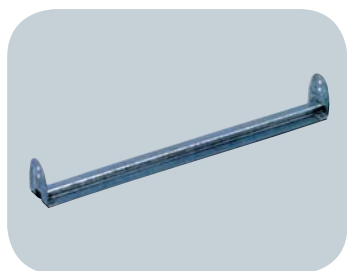

Motor mounting bracket and support flange

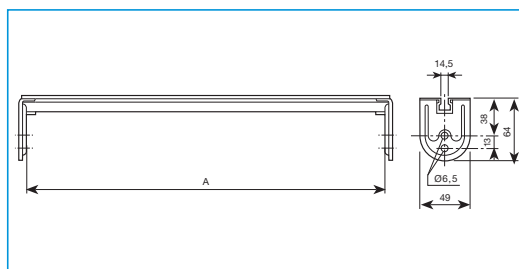

Model	A
CBP-7/7	232
CBP-9/7	232
CBP-9/9	300
CBP-10/8	266
CBP-10/10	333
CBP-12/9	311

Model	A
CBP-12/12	396
CBP-15/11	373
CBP-15/15	473
CBP-18/13	436
CBP-18/18	556



■ **Range of products**



CBP
Double inlet centrifugal fans

11 models:
From 7/7 to 18/18



CBP- RC
Double inlet centrifugal fans

11 models:
From 7/7 to 18/18



CBP-RE
Double inlet centrifugal fans

5 models:
From 18/18 to 30/28

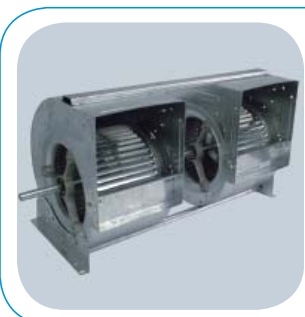

CBP-D
Double inlet duplex centrifugal fans

11 models:
From 7/7 to 18/18



CBP-DC
Double inlet duplex centrifugal fans

11 models:
From 7/7 to 18/18



CBP-DE
Double inlet duplex centrifugal fans

14 models:
From 9/7 to 30/28

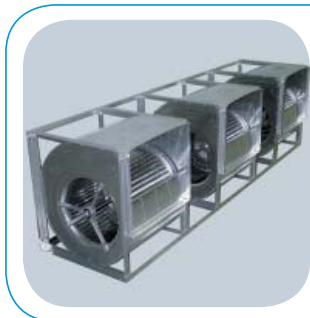

CBP-TC
Double inlet triplex centrifugal fans

10 models:
From 7/7 to 18/18

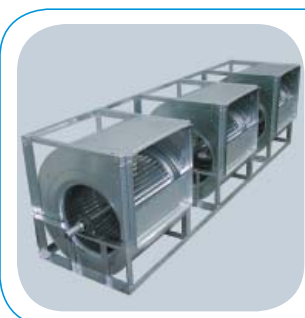

CBP-TE
Double inlet triplex centrifugal fans

14 models:
From 9/7 to 30/28



CBS
Single inlet centrifugal fans

9 models:
From 9/4 to 30/14